



1934GRK

solid sprung door handle on clover rose

Product information

Code: 2001D030NMEB0

Finish: satin black

UNIT: Pair

Collection: TIMELESS

Designer: Formani

EAN code: 8718009363805

TIMELESS by Formani

The TIMELESS series is a total concept collection consisting of door, window, and furniture fittings.

Finishes

- satin nickel
- bright nickel
- brass unlacquered
- satin black

1934GRK

sprung lever handle
attached to rose
brass

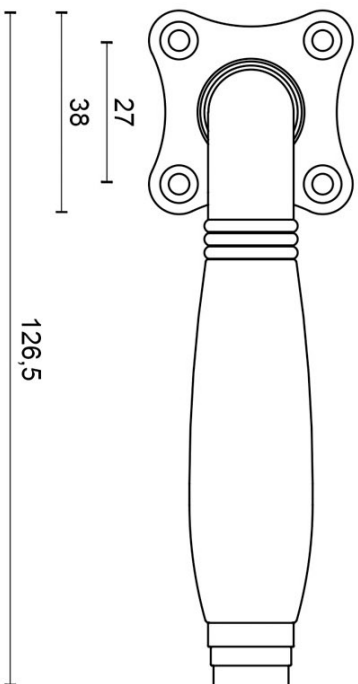
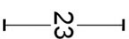
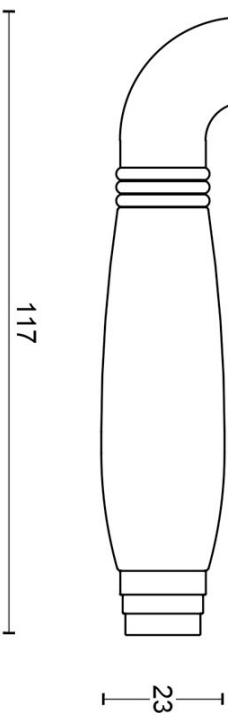
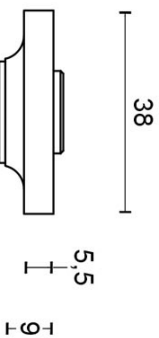
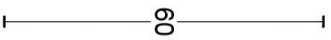
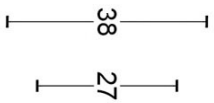
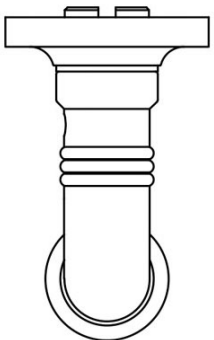
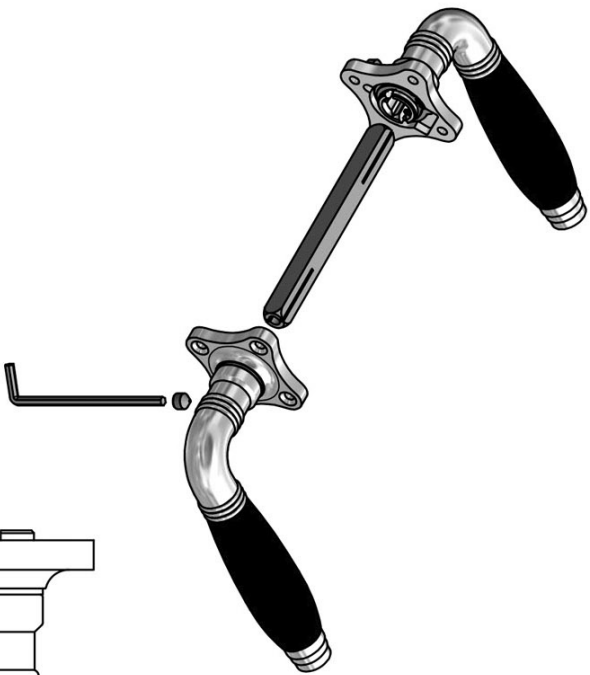

FORMANI®		Part number:	1934GRK	A3
Doc no.: 2001D030 1934 GRK V01.dwg		Description:		
Drawn by: Christian Brimbois	Creation date: 29-8-2017			
FORMANI HOLLAND B.V. - EUROPALAAN 12 6199 AB MAASTRICHT-AIRPORT NL. T. +31 (0)43 308 90 00 INFO@FORMANI.COM FORMANI.COM				

TIMELESS

by Formani

Authenticity is what defines our TIMELESS hardware series. As the name of the series implies, the comprehensive range has stood the test of time. It comprises products from times gone by that have been given a new lease of life by FORMANI – some of which combined with elements of modern technology and functionality. The designs of the door handles in the TIMELESS collection can be traced back to the period from 1815 to 1950. The models are each named after the year in which they are fashioned. Besides the door handles, the TIMELESS series offers window and cabinet hardware and comprehensive accessories that complete the entire design. The products are available with authentic flat rosettes and shields, fastenings with vintage-design screws, materials such as brass as a base material – sometimes complemented by ebony – and original finishes in matte or glossy nickel and unlacquered brass. Where required, this authentic design is combined with contemporary technology such as SKG* safety fittings, spring mechanisms, and special PVD coatings to offer protection in the event of outdoor use.**

TIMELESS

by Formani



FORMANI®

Brand story

FORMANI has evolved considerably over the last few decades – from a Dutch family business to an internationally renowned designer brand, from door handles to total design concepts, from product development to collaborations with world-class designers. It was an evolution driven by pure ambition and courage. Our motto, ‘Obsessed with details’, epitomizes everything we do, from product to process, from strategy to service. Because it is these details that make the difference between good and perfect. At FORMANI, good is the enemy of great.

Formani Holland b.v.
Europalaan 12
6199 AB
Maastricht-Airport

T: +31(0)43 308 9000
E: info@formani.com

Chamber of Commerce:
146 27 479

FORMANI®