



BBWCQ50

turn and release set on square rose including Q5/6/7/8 spindle

Product information

Code: 3301T002NMXXU

Finish: satin black

UNIT: Set

Collection: TENSE

Designer: Bertram Beerbaum

EAN code: 8718009346259

TENSE by Bertram Beerbaum

The TENSE series is a total concept collection consisting of door, window, and furniture fittings.

Finishes

- satin stainless steel
- satin black

TENSE BBWQ50

lever handle accessory
privacy set
stainless steel

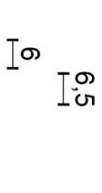
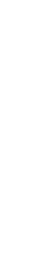
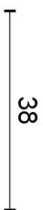
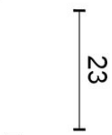
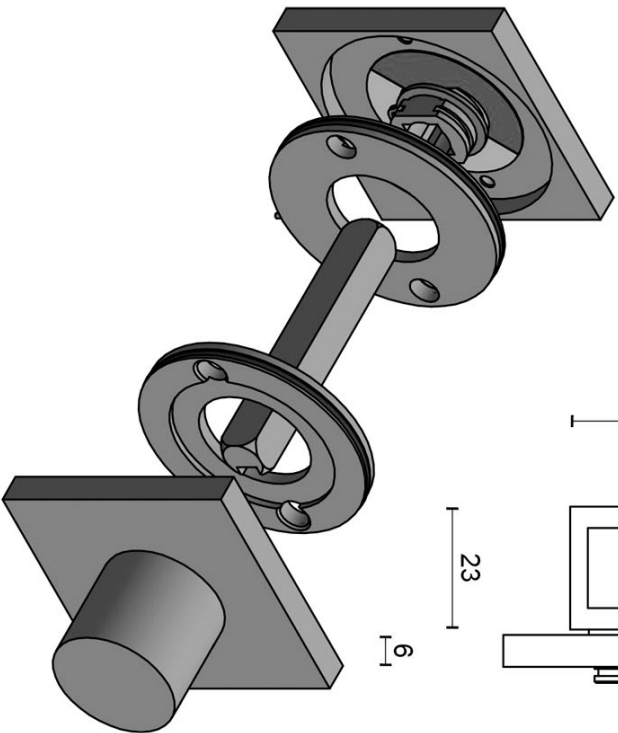
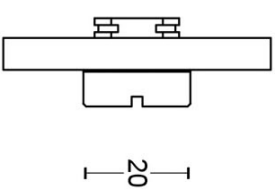
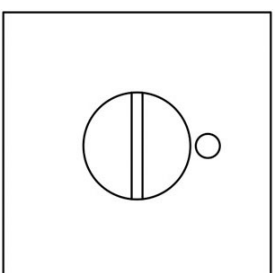
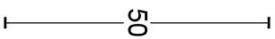
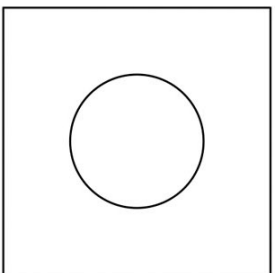
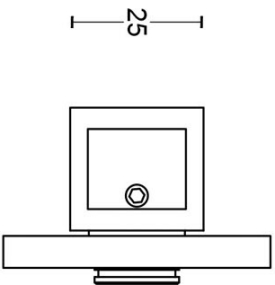
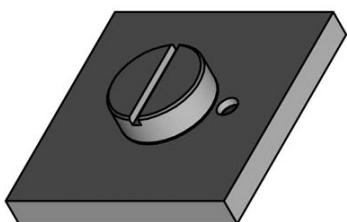
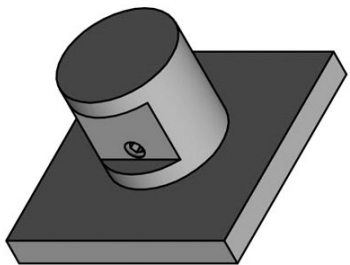

FORMANI®		Part number:
Doc no.:	3301T002 TENSE BBWQ50 V01.dwg	Description:
Drawn by:	Christian Brimbois	
Creation date:	16-2-2016	TENSE BBWQ50
FORMANI HOLLAND B.V. - EUROPALAAN 12 6199 AB MAASTRICHT-AIRPORT NL T. +31 (0)43 308 90 00 INFO@FORMANI.COM FORMANI.COM		Format:
		A3

TENSE

by Bertram Beerbaum

Designed by Bertram Beerbaum, our TENSE hardware series is guided by a clean aesthetic that is as robust as it is chic. Every design in the series is unique while at the same time bearing the unmistakable TENSE signature. The core of every design is the cylindrical neck to which each rectangular lever is connected in its own unique way. This is thanks to our extreme high precision welding technique, which forms a secure joint between two very different shapes. The unique characteristics of the design received an honorable mention during the German Design Awards, one of the most prestigious design contests. TENSE by Bertram Beerbaum is a total concept collection including door, window, and furniture fittings and is available in the colours stainless steel, satin black, and bronze.

TENSE

by Bertram Beerbaum

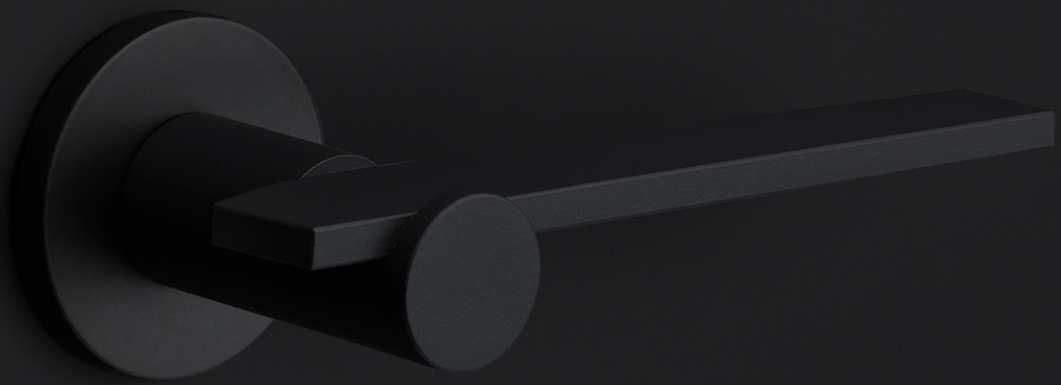

FORMANI®



Bertram Beerbaum

Hilversum, 1976

Design philosophy: I prefer to design a product that combines design and convenience in a natural way. Any product that I design must be something tough, chic, timeless and a tad own wisdom in them. Functional products with a surprising twist.

Bertram Beerbaum prefers to design products in a convenient but natural way. Any product that he designs must be stylish, chic, and timeless, yet refreshingly idiosyncratic. These are products that combine function with a surprising twist. According to his design philosophy, door fittings must both look good and have a comfortable grip. But most importantly, the design should be in perfect harmony with the building's architecture. An inspiring encounter with Bertram Beerbaum generated innovative and exciting ideas and ultimately resulted in the introduction of the fantastic TENSE collection..

Brand story

FORMANI has evolved considerably over the last few decades – from a Dutch family business to an internationally renowned designer brand, from door handles to total design concepts, from product development to collaborations with world-class designers. It was an evolution driven by pure ambition and courage. Our motto, ‘Obsessed with details’, epitomizes everything we do, from product to process, from strategy to service. Because it is these details that make the difference between good and perfect. At FORMANI, good is the enemy of great.

Formani Holland b.v.
Europalaan 12
6199 AB
Maastricht-Airport

T: +31(0)43 308 9000
E: info@formani.com

Chamber of Commerce:
146 27 479

FORMANI®