



LB2L-22

sprung door handle on rose EN1906 class 3

Product information

Code: 1501D152INXX0L

Finish: satin stainless steel

UNIT: Pair

Collection: BASICS

Designer: Formani

EAN code: 8718009410905

BASICS by Formani

The BASICS series is a total concept collection consisting of door, window, and furniture fittings.

Finishes

- satin stainless steel
- satin black

BASICS LB2L-22 EN1906 GRADE 3

sprung lever handle attached to rose
with stainless steel sub-rose
stainless steel

CERTIFICATE SKG.0338.8049.04.ENG
EN1906

3	7	B	0	3	0	B
---	---	---	---	---	---	---

 14.00343-1

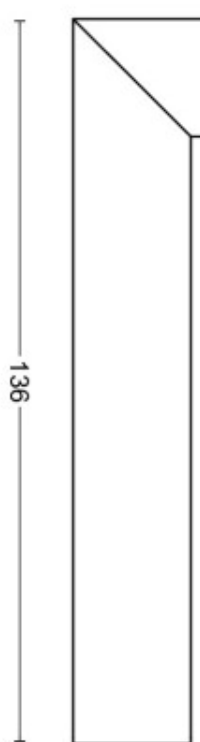
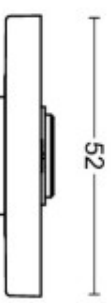
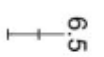
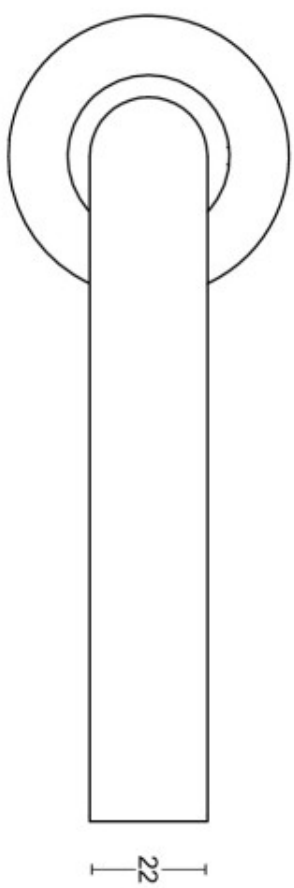
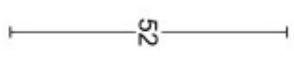
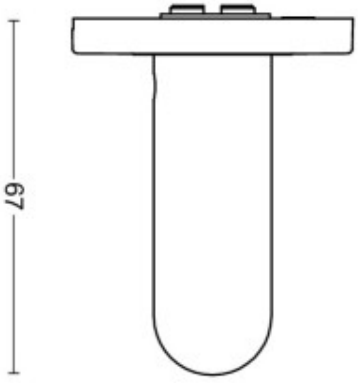
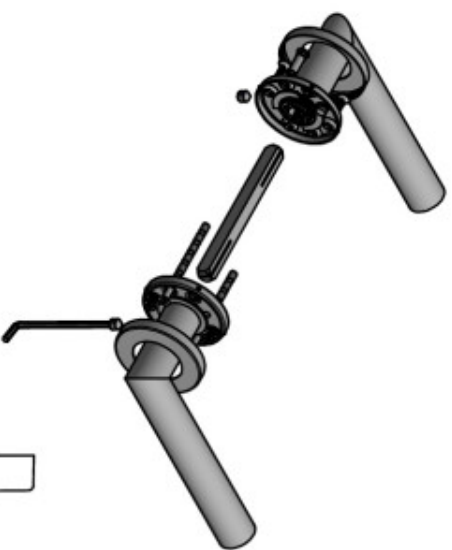

door thickness 38 - 45 mm

		FORMANI HOLLAND B.V. EUROPAALAN 12 6199 AS MAASRICHT-LARPOORT NL T +31 (0)43 200 9200 W WWW.FORMANI.COM M WWW.FORMANI.COM	
Formani filename:	1501D152_LB2L-22_EN1906_V02.dwg	Type :	BASICS LB2L-22 EN1906 GRADE 3
Drawn by:	Semih Aslan	Description:	sprung lever handle attached to rose with stainless steel sub-rose stainless steel
Creation date:	4-3-2022	Version:	V01
		Format:	A3

BASICS

by Formani

As a comprehensive total concept collection, our BASICS hardware series brings together various designs that are suitable for any budget. The designs are as understated, simple, and pure as they are luxurious, imparting an exquisite finishing touch to any interior and exterior design. We have developed this series because we would like to share OUR OBSESSION WITH DETAILS with everyone, regardless of the budget. The BASICS series consists of door, window, and furniture hardware alongside other accessories. The products are produced from stainless steel and are available in a variety of fashionable colours, including satin black, satin gold, copper, and base colours such as matte and polished stainless steel. Some products in this series have an EN1906 class 3 certification.

BASICS

by Formani

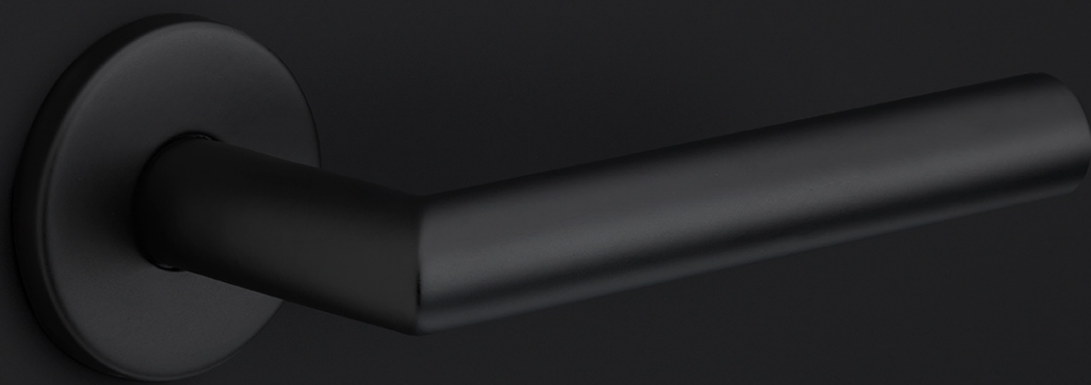

FORMANI®

Brand story

FORMANI has evolved considerably over the last few decades – from a Dutch family business to an internationally renowned designer brand, from door handles to total design concepts, from product development to collaborations with world-class designers. It was an evolution driven by pure ambition and courage. Our motto, ‘Obsessed with details’, epitomizes everything we do, from product to process, from strategy to service. Because it is these details that make the difference between good and perfect. At FORMANI, good is the enemy of great.

Formani Holland b.v.
Europalaan 12
6199 AB
Maastricht-Airport

T: +31(0)43 308 9000
E: info@formani.com

Chamber of Commerce:
146 27 479

FORMANI®